

THE MEASUREMENT SOLUTION.

burster

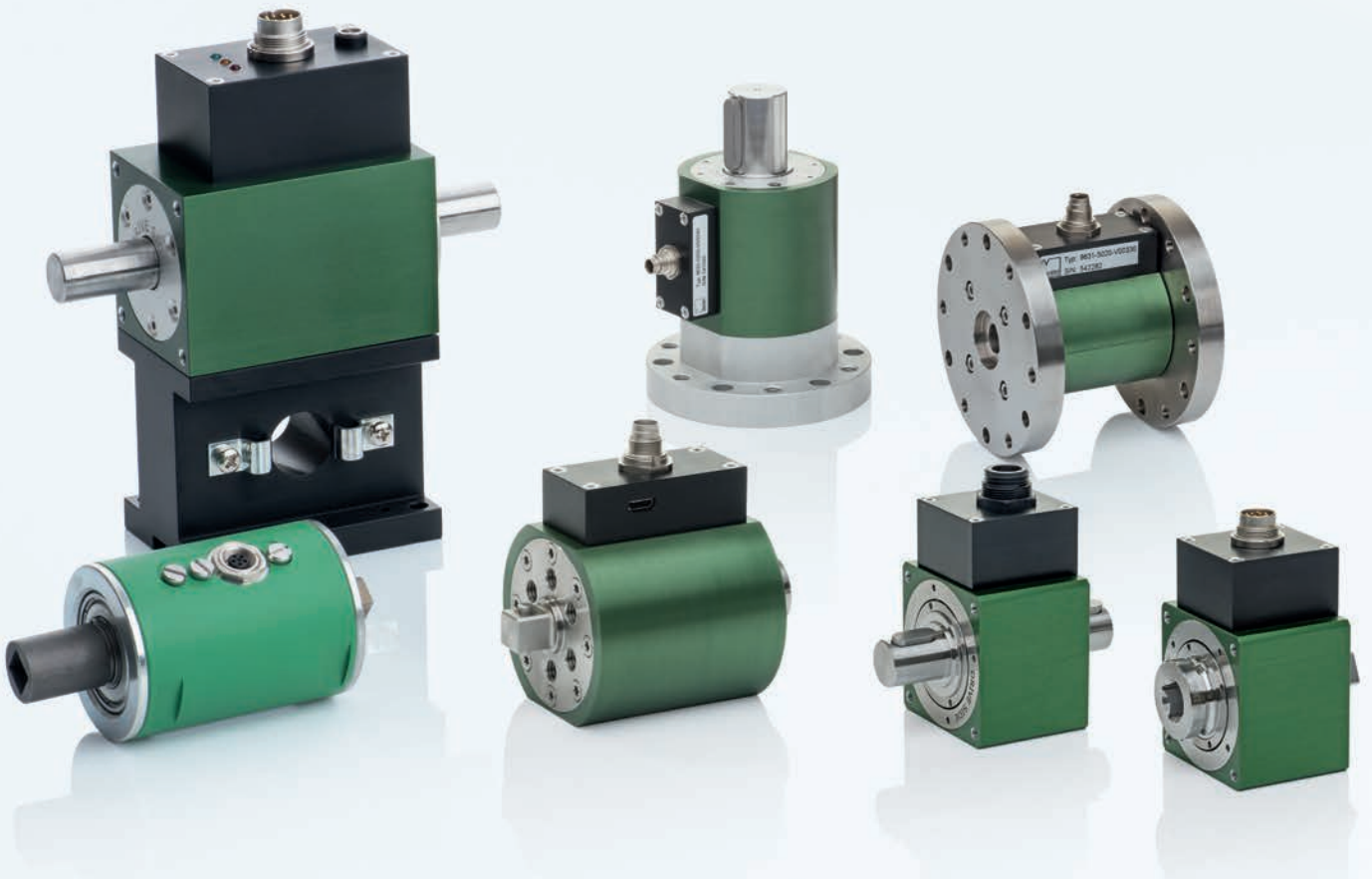

Torque Sensors

**FOR PRODUCTION, AUTOMATION, R&D
AND QUALITY ASSURANCE**

Always finding the right moment

SMART TORQUE SENSORS KEEPING PACE WITH ADVANCES IN PROCESS CONTROL.

PRODUCTS DESIGNED FOR THE CHALLENGES OF OUR AGE

Our customers operate in practically every branch of industry around the world and expect products to work perfectly 100% of the time. As the requirements set by exacting production processes and quality assurance standards become ever more stringent, process control depends increasingly on sensors and analysis equipment.

As one of the leading manufacturers of torque sensors, we can provide innovative ideas, experience-led advice and smart solutions for all production and quality assurance processes. Our customers value our extensive applications experience and our high-quality, practical solutions to the demands of the market.



VARIABLE CHALLENGES NEED VERSATILE SOLUTIONS

In addition to innovative and trusted standard products in rotating and non-rotating measurement applications, we also develop custom sensor solutions for very specific measurement tasks and specialized applications.

It is essential to look at the process chain in depth to find the right torque sensor for the job and environment. Along with the ideal torque sensor, a measurement system requires mechanical parts plus instrumentation for measurement data acquisition, analysis and reporting.

burster offers high-quality torque calibration equipment plus extensive testing and calibration experience to guarantee the traceability and optimum reliability you need. Analysis software and a comprehensive suite of customer services complete the burster package of solutions.

RELIABILITY AT YOUR FINGERTIPS – burster PLUG & PLAY

Smart interaction is the key to success in a world where sharing information is ever more important. Interconnecting people, machinery and products in fully or semi-automated production processes is a challenging and demanding reality. Engineers must design processes to be easy to monitor, quantify and analyze while aiming for ever greater reliability.

Sensor-specific data is stored in the sensor connector using innovative burster TEDS technology. The analysis instrument reads this sensor data and uses it for the automatic configuration of the evaluation electronics. This not only protects against setting incorrect parameters but makes it easier to change sensors while saving time and money spent on configuration.



Success in practice

burster TORQUE SENSORS CAN HANDLE EVERY CHALLENGE.

FROM THE SPECIFIC TO THE UNIVERSAL – GLOBAL SOLUTIONS

Torque measurement is increasingly relevant to growth markets such as drive technology, automotive engineering, electro-mobility and medical technology. burster has many years' experience designing, building and using torque sensors and in providing valuable applications advice in many different industrial and research sectors, making burster expert in solving torque measurement problems. **Take advantage of our experience now to gain that competitive edge.**

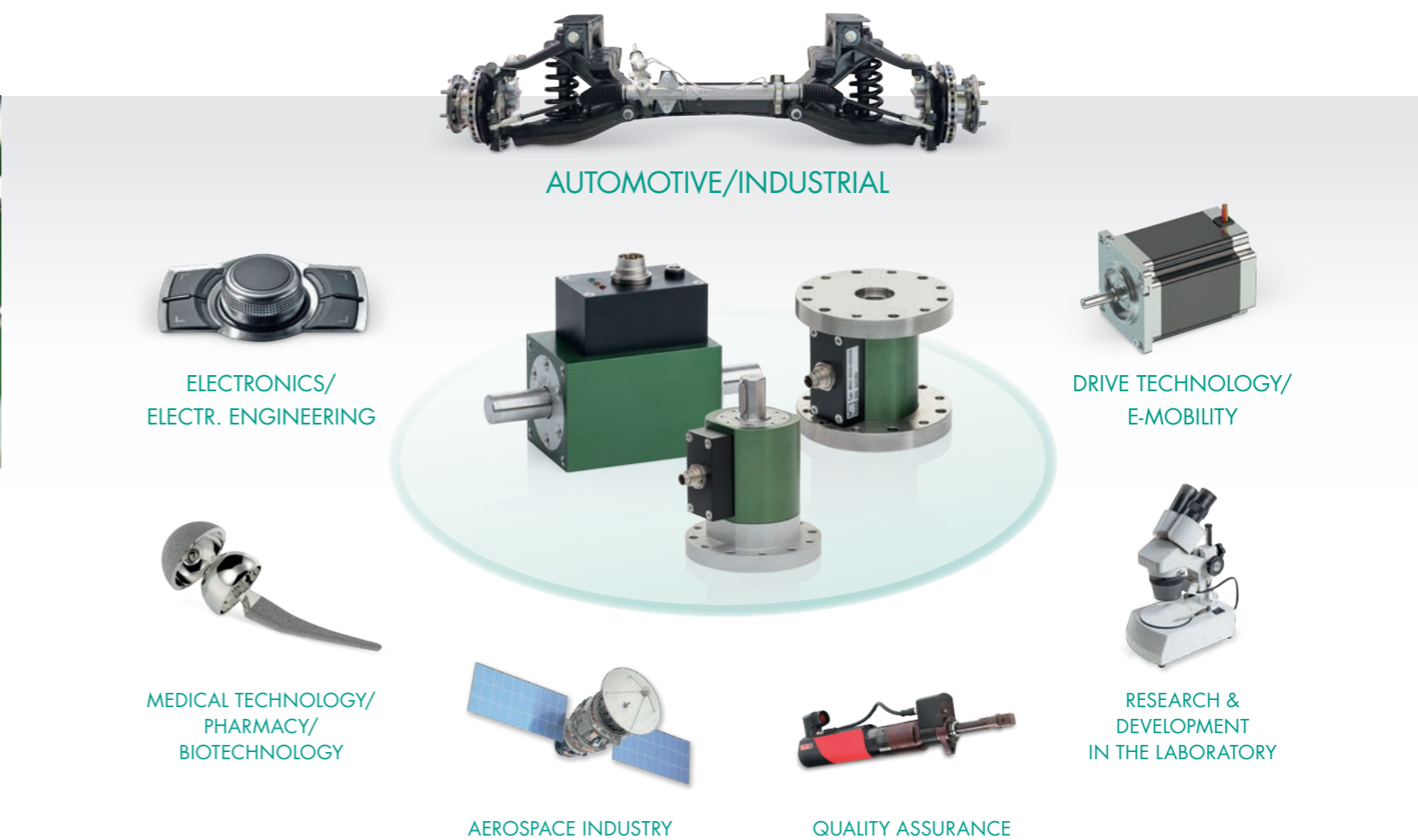

SIMPLE OR COMPLEX – BE IN CONTROL WHATEVER THE MEASUREMENT TASK

As a torque sensor manufacturer with decades of design and production experience gained within the same company, burster is able to offer custom solutions for highly specialized applications. Our skills portfolio ranges from solving simple torque measurement tasks to designing complex torque monitoring systems.

For instance, the **DIGIFORCE® 9307 high-end process controller** combines with the **8661 high-precision torque sensor** to provide an unbeatable torque measurement system for reliable and safe monitoring of your process. This system not only allows complex monitoring of a torque/angle characteristic but also delivers process-safe and reliable fieldbus-compatible OK/NOK evaluation.

**Standard product, custom solution or an exclusive OEM product?
Low-cost or high-end? Which route do you want to take with us?**

Torque sensors

FOR ROTATING APPLICATIONS.

PRECISION TORQUE SENSOR 8661

Thanks to its excellent measurement performance and outstanding electrical and mechanical properties, **this compact all-rounder** is ideal for applications where precision, functionality and process integration are still essential even when measuring very small torques. An excellent price-performance ratio makes this sensor a worthwhile and safe investment.



Features

- Measurement ranges of 0 ... 0.02 Nm to 0 ... 1000 Nm
- Output voltage 0 ... ±10 VDC or USB with Lab VIEW/DLL interface
- Intelligent operating state indicator

Highlights

- Linearity error as low as from 0.05 % F.S.
- Variable dual-range model (option)
- Angle measurement with resolution of up to 2000 increments

Options

- Variable dual-range model
- Output 0 ... ±5 VDC or USB
- Angle/speed measurement
- Keyways
- German-accredited DAkkS or factory calibration certificate



on mounting block with couplings

Applications

- Precision friction torque measurements on bearings
- Measurements on micromechanical actuator elements
- Suitable as test-bench measuring device
- Engine test benches incl. measurement of mechanical power

Accessories

Metal-bellows couplings

Ultra-easy to fit thanks to compact and torsionally stiff design with zero backlash

DigiVision PC software

Convenient configuration and analysis software that is practical and intuitive to use

Mounting block

Useful for frequent sensor changes, making it easier to fit and mechanically align the sensor

Sensor instrumentation

Display/evaluation units, fieldbus modules, complex process control systems supplied ready for use

Applications

TURNING MOMENTS INTO IMPRESSIVE SOLUTIONS.

PRECISION TORQUE SENSOR 8661

↳ Torque/angle measurement on vehicle dashboard controls

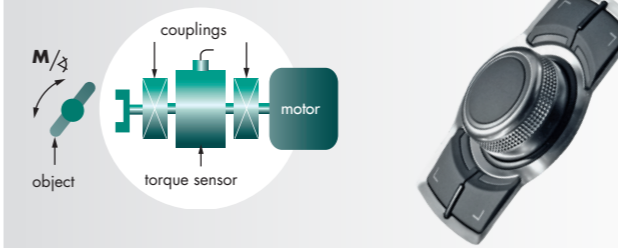

Highlights

- Torque measurement < 0.05 Nm
- Angle resolution 0.0885 °

Benefits

- Simplified construction because there is no need for an additional high-resolution angle sensor

When monitoring the haptic response of a rotary switch, it is important to measure precisely the torque that must be applied (adjustment force required > proprioceptive sensation > tactile

sensation). The 8661 torque sensor can be used to measure reproducibly and extremely accurately ultra-low torques over a defined angle range during forward and return movement.

↳ Measuring the friction torque in greased ball bearings

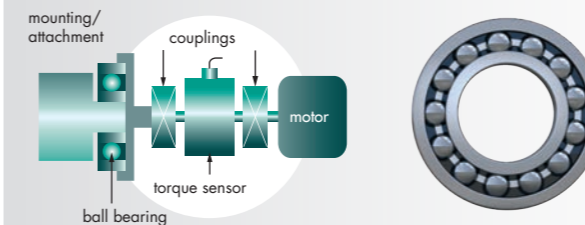

Highlights

- Torque measurement < 0.1 Nm
- Speed measurement up to 20000 1/min
- Includes built-in USB port

Benefits

- High measurement cycle rates
- Visualization and data logging in one measurement step

The torque is applied using a variable-speed controlled asynchronous AC motor. Depending on the amount of grease in the ball bearing, the motor is run at different speed levels for various time intervals in order to obtain continuous measurements of the

friction torque during continuous operation, and to transfer these measurements via USB port to the DigiVision PC software for visualization and data logging.

↳ Dual-range model for measuring start-up and continuous operation characteristics of geared motors

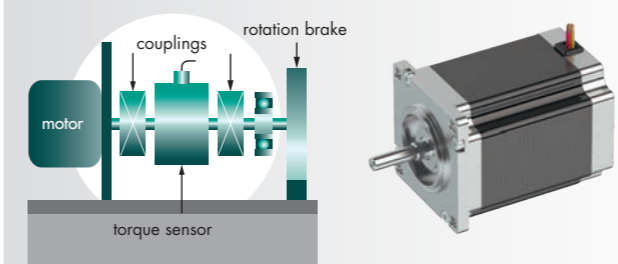

Highlights

- Dual-range model
- Ratio 1:10
- High precision for both measurement ranges
- Scaled standard signal output for both measurement ranges

Benefits

- No downtimes for sensor replacement
- Cost savings

In order to improve the electromechanical energy conversion in geared motors in different load scenarios with a view to long operating lives, it is essential to measure mechanical, electrical and thermal characteristics in endurance testing. During the start-up phase under load, disproportionately high starting torques often arise that lie

well above the steady-state load torque. The dual-range model can be used to measure precisely and reliably the starting torque in the first measurement phase and the steady-state load torque in the second phase. The change to the second measurement range is made by applying a signal level to the switchover channel.

Torque sensors

FOR ROTATING APPLICATIONS.

TORQUE SENSOR 8645/8646

This sensor's easy-to-use design and particularly attractive price open up a wealth of potential uses even for highly price-sensitive applications. A rugged construction and the nominal temperature range create new opportunities where cost and complexity would previously have ruled out direct torque measurements.

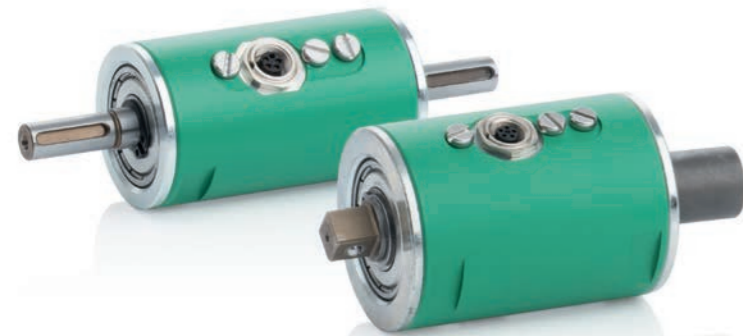

Features

- Measurement ranges of 0 ... 2.5 Nm to 0 ... 500 Nm
- Extremely good value and zero maintenance
- Built-in instrumentation amplifier

Highlights/Options

- Tolerates high transverse forces and bending moments
- Nominal temperature range -40 °C up to 85 °C
- German-accredited DAkkS or factory calibration certificate

TORQUE SENSOR 8655/8656

Mechanical adaptability and precision measurement properties make this sensor range ideally suitable to a huge variety of screw-action applications. Also ideal for use in other industrial applications thanks to static and short-term dynamic measurement capability in either direction of rotation.



Features

- Measurement ranges of 0 ... 1 Nm to 0 ... 200 Nm
- Very compact
- Choice of mechanical adapters
- Output voltage ± 10 V or USB

Highlights/Options

- Includes integral angle/speed measurement (option)
- Internal square and external square
- German-accredited DAkkS or factory calibration certificate

Applications for the 8645/8646 and 8655/8656 sensors

- Testing screwdrivers
- Torque measurement on screw jacks
- Use in conveyor systems
- Measuring drag and friction torques in motors and pumps
- Measuring drive torques in drilling systems

Applications

TURNING MOMENTS INTO IMPRESSIVE SOLUTIONS.

TORQUE SENSOR 8645

↳ Torque measurements on hinges

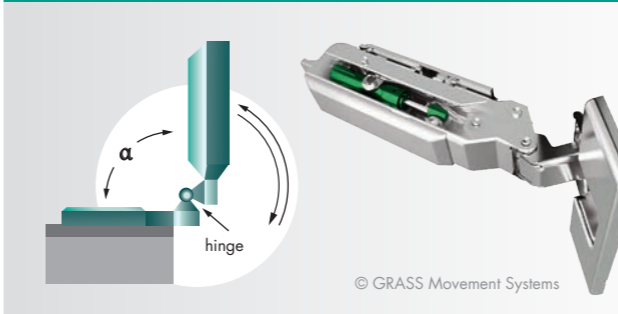

Highlights

- Contact-less torque measurement up to 7.5 Nm
- Built-in instrumentation amplifier

Benefits

- Maintenance-free sensor, excellent value for money
- Suitable for use in harsh conditions thanks to ultra-rugged sensor design

The torque characteristic in different detent positions of door hinges is measured over a preset angle. The 8645 torque sensor is used in final testing for 100% measurement of the alternating bidirectional torque characteristic. Slight axial forces inherent in

the test station design have no impact on the stability and service life of the torque sensor thanks to the mechanical design and specific measurement procedure.

TORQUE SENSOR 8655

↳ Monitoring a screw-fastening process

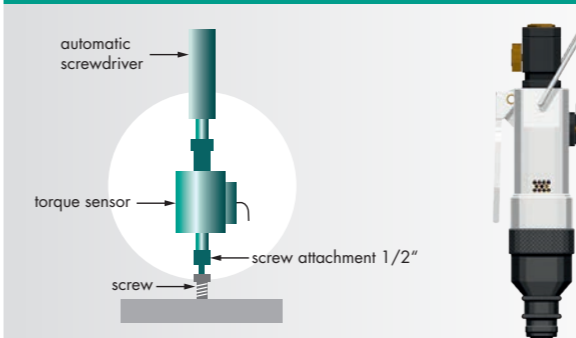

Highlights

- Direct mechanical coupling without internal/external square drive adapters
- Integral speed measurement

Benefits

- Low space requirement
- Easy to fit

For checking and calibrating an automatic screwdriver with built-in torque monitoring at the start of a shift, the 8655 sensor is fitted directly between screwdriver and screw attachment. The re-

corded screw-fastening data is used as a reference for the signal from the automatic screwdriver.

TORQUE SENSOR 8656

↳ Testing E-bike drives

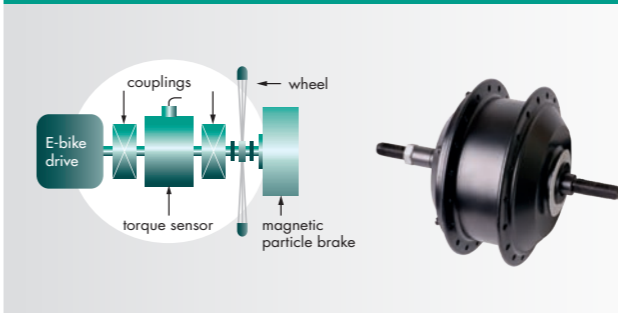

Highlights

- High measurement accuracy
- Integral speed measurement

Benefits

- Fits into small space
- Easy to integrate and fit

After the assembly of E-bike drives they are subject to a long term test. An air-cooled magnetic particle brake is used as the load. The object under test is fixed using a manual quick-release clamp.

The 8656 torque sensor is used in the low-speed range (1 to 255 rpm) to acquire and evaluate the ACTUAL and SET-POINT torques while measuring the speed.

Torque sensors

FOR NON-ROTATING APPLICATIONS.

HIGH-PRECISION TORQUE SENSOR 8625

The sophisticated design and unrivalled measurement capabilities of this high-precision torque sensor can be enjoyed in a vast range of applications thanks to its modular mechanical and electrical design.

Features

- Measurement ranges of 0 ... 0.01 Nm to 0 ... 200 Nm
- Versatile mechanical fitting options
- Excellent price/performance ratio

Highlights

- Linearity error as low as from 0.05 % F.S.
- Optional USB port can be used for TARE, filter and average value settings
- Wide nominal temperature range -20 °C up to 80 °C

Options

- Analog output 0 ... ±10 VDC and USB
- burster TEDS
- Suitable for mounting on flange or bracket
- German-accredited DAkkS or factory calibration certificate



with flange



with bracket

Applications

- Test setups for precision mechanics
- Measuring the torques applied to vehicle dashboard controls
- Reaction torque measurements on motors
- Measuring holding torques on frictional connections

Accessories

Metal-bellows couplings

Ultra-easy to fit thanks to compact and torsionally stiff design with zero backlash

DigiVision PC software

Convenient configuration and analysis software that is practical and intuitive to use

Connecting cables

A large range of high-quality connecting cables are available to fit all burster instruments or as unterminated cables with free soldered wire ends

Sensor instrumentation

Display/evaluation units, fieldbus modules, complex process control systems supplied ready for use

Applications

TURNING MOMENTS INTO IMPRESSIVE SOLUTIONS.

HIGH-PRECISION TORQUE SENSOR 8625

Measuring the static latching torque for plastic bearings

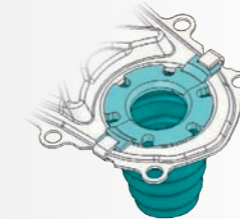
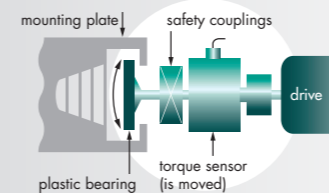

Highlights

- Linearity error 0.05 %
- Analog output signal ±10 VDC

Benefits

- Built-in instrumentation amplifier cuts susceptibility
- End-mounting facility simplifies mechanical construction

Two precisely positioned plastic bearings are simultaneously fitted in a mounting plate by rotating through a fixed angle of 13°. The friction torque and latching torque lie in the range of 4.7 Nm to 9 Nm. The 8625 torque sensor is used not only to detect the jump in torque as the part engages but also to measure the

friction torque needed while the part is running under the tab until it engages. The minimal linearity error allows tightly-toleranced monitoring of the distinct process stages. A safety coupling protects against overloading the torque sensor.

Non-rotating torsion measurement on elastic rubber dampers

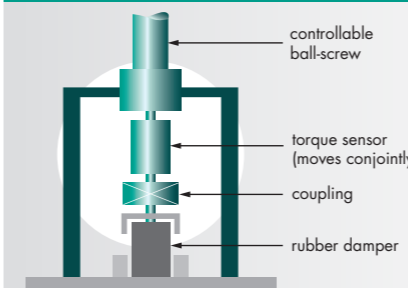

Highlights

- USB port
- TARE function

Benefits

- Good value sensor solution

The torsion and elasticity behaviour of rubber dampers is analyzed in a test apparatus. The object under test is twisted through a small angle. The 8625 torque sensor, which is rotated conjointly, detects the anticlockwise and clockwise torque. The DigiVision PC

software reads the sensor measurements via the USB port on the basis of the set trigger criteria, then visualizes and documents this data.

Measuring the static torque on tank cap systems

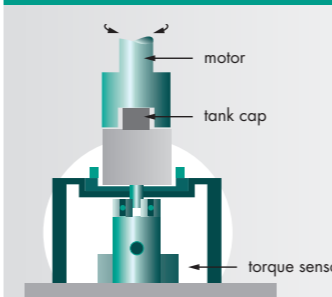

Highlights

- Nominal temperature range -20 °C up to 80 °C
- Flange-mounted model

Benefits

- Extremely easy to fit

The static torque needed to open and close safety tank cap systems on hazardous material containers (to overcome the catch/retaining force in both directions) is measured under various test criteria (level of soiling, number of open/close operations, gasket seating, etc.). The flange-mounted model of the 8625 torque sensor is very easy to fit in the particular application. The support for the object

under test and the weight exerted by the test object are decoupled from the measuring element. Temperature variations arising from ambient conditions and the nature of the hazardous material have only minimal impact on the measurement quality thanks to the wide nominal temperature range.

Torque sensors

FOR NON-ROTATING APPLICATIONS.

TORQUE SENSOR 8630

The ultra-rugged miniature square-shaft torque sensor features outstanding measurement and mechanical properties. The mechanical process connections and the optimized design make this torque sensor ideal for use in a huge variety of screw-action applications.



with bracket



with flange

Features

- Measurement ranges of 0 ... 1 Nm to 0 ... 200 Nm
- Choice of mechanical adapters

Highlights/Options

- Linearity error of 0.1 % F.S.
- Output voltage ± 10 V and USB
- Suitable for mounting on flange or bracket
- burster TEDS
- German-accredited DAkkS or factory calibration certificate

FLANGE TORQUE SENSOR 8631

Accurate measurements of reaction torques and of constantly present torques are equally easy using this flange torque sensor. The small angle of twist and rugged mechanical design make this sensor suitable for both static and dynamic non-rotating torque applications.



Features

- Measurement ranges of 0 ... 5 Nm to 0 ... 200 Nm
- Rugged and reliable
- Very easy to use and fit

Highlights/Options

- Linearity error as low as from 0.1 % F.S.
- Output voltage ± 10 V and USB
- Tolerates high axial forces and bending moments
- burster TEDS (option)
- German-accredited DAkkS or factory calibration certificate

Applications for the 8630/8631 sensor

- Measuring the opening torques on screw caps
- Measuring the reaction torque on drives
- Quality assurance for screw-action applications
- Measurement of friction torques

Applications

TURNING MOMENTS INTO IMPRESSIVE SOLUTIONS.

TORQUE SENSOR 8630

Non-rotating tightening-torque measurement on hand-guided electric screwdrivers

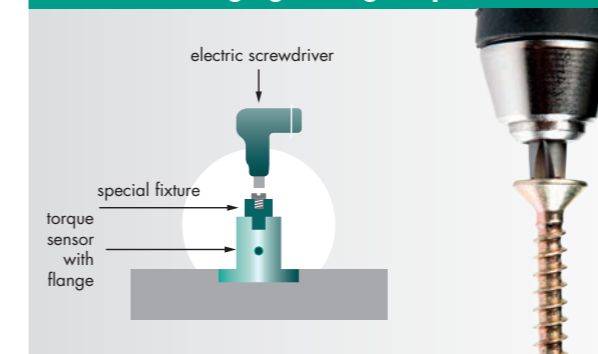

Highlights

- Low profile
- Bending moments have no impact by additional support bearings

Benefits

- Standard square shaft
- Excellent value for money
- Suitable for use in harsh conditions thanks to ultra-rugged sensor design

In a simple test station for electric screwdrivers, an 8630 non-rotating torque sensor is used to measure the screw tightening torque in M4 to M6 screw connections. This involves fixing in place the torque sensor with fitted flange. The various screw sizes are

screwed into specially made fixtures, and the maximum tightening torque is measured. The aim is to optimize the torque set in the electric screwdriver to avoid over-tightening screws, to optimize downtimes, etc.

FLANGE TORQUE SENSOR 8631

Non-rotating torque measurement on bulk-material filling equipment

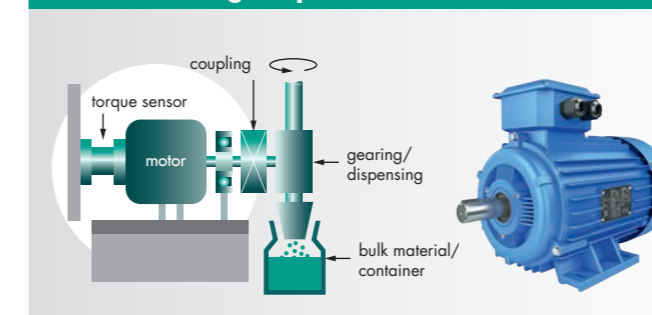

Highlights

- Automatic sensor identification through burster TEDS

Benefits

- Easy to fit and integrate in process
- Zero-maintenance torque measurement

The requirement is to measure continuously the torque acting on a geared unit with dispenser on continuously running equipment used for filling bulk-material containers. This is achieved by fitting a 8631 flange sensor directly on the drive motor, with no axial offset, for a static torque measurement. Additional support is provided

for the motor to avoid any axial load or bending moment on the sensor. The through-holes around the flange circumference make for easy fitting. An additional analysis instrument identifies the sensor automatically. Limits are used to monitor for load spikes and protect the system against overload.

Accessories

Metal-bellows couplings

Ultra-easy to fit thanks to compact and torsionally stiff design with zero backlash

DigiVision PC software

Convenient configuration and analysis software that is practical and intuitive to use

Connecting cables

A large range of high-quality connecting cables are available to fit all burster instruments or as unterminated cables with free soldered wire ends

Sensor instrumentation

Display/evaluation units, fieldbus modules, complex process control systems supplied ready for use

OEM torque sensors

FOR NON-ROTATING AND ROTATING APPLICATIONS.

burster's in-house design and production departments also develop and manufacture high-quality torque sensors that provide exceptional field-tested features for very specific tasks.

They are in use all around the world in the most diverse applications and industry sectors. If the sensors presented here do not match your requirements profile, we will be happy to design the perfect solution to fit your needs.

OEM TORQUE SENSOR ROTATING

During fully automatic production of electric motors, the assembly line requires information on the torque and the position of the motor shaft. Thanks to the fit provided by the housing boss, the sensor can be replaced without realignment.



Features

- Measurement ranges of 0 ... 10 Nm
- Includes built-in instrumentation amplifier 0 ... ±10 VDC

Highlights/Optionen

- Includes Z-groove for absolute position measurement
- Housing boss with h5 fit
- Angle measurement resolution of 0.045 °

OEM TORQUE SENSOR ROTATING

For measuring the adjustment torque in space satellites with simultaneous position measurement.



Features

- Measurement ranges of 0 ... 5 Nm
- Includes built-in instrumentation amplifier 0 ... ±10 VDC

Highlights/Optionen

- Integral sensor connecting cable can be used from -190 °C to +200 °C
- Measuring shaft with customized mechanical design
- Angle measurement resolution of 0.0885 °

OEM TORQUE SENSOR NON-ROTATING

Measurement of the torque that is required to operate a control lever in the aviation industry.



Features

- Measurement ranges of 0 ... 50 Nm
- Very compact design

Highlights/Optionen

- High axial load
- Custom hole pattern available

DigiVision

POWERFUL DATA ACQUISITION AND ANALYSIS SOFTWARE.

EVERY PROCESS RELIABLY IN VIEW

Offering multi-channel capability and designed for convenient PC-based acquisition, analysis and documentation of your measurement data, our software is ideal for mobile and fixed applications in the laboratory, in R&D and in industrial environments.

Compatible with all torque sensors with built-in or external USB interface. Depending on the sensor model, the software can be used to capture, visualize and document speed and angle alongside torque. DLL and LabView drivers are available free of charge for quick and cost-neutral integration into an existing software environment.

DigiVision Professional offers not only configurable mathematical functions and high-speed measurements but also features connectivity for other measurement parameters required for more complex analysis of an object under test. Mathematical add-on functions can also be used to generate virtual channels, for example channels which visualize and evaluate a calculated result.

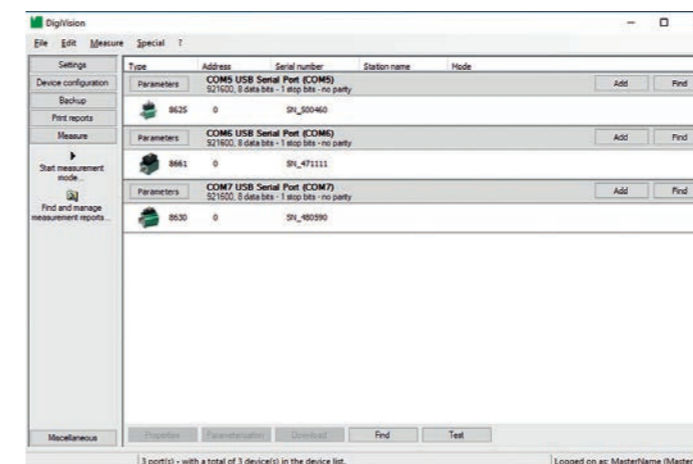
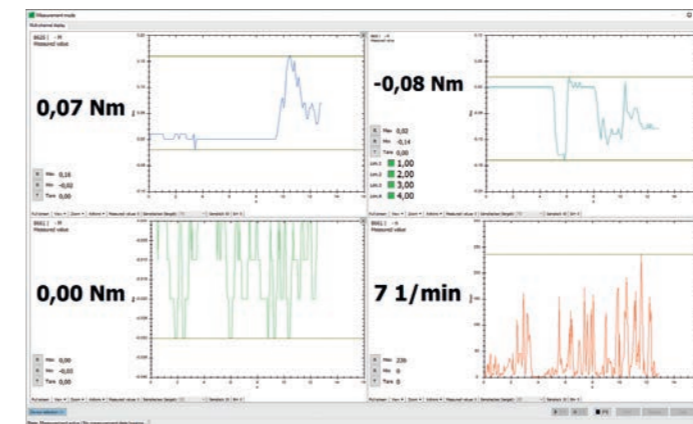

DigiVision is available in three versions – to meet your specific needs.

DigiVision LIGHT

- Numerical/graphical display of torque, speed, angle and mechanical power
- Can be configured for MIN/MAX acquisition with 4 limits/channel

DigiVision STANDARD (add-on functions)

- Measurement rate up to 1200 measurements/s
- Supports up to 16 measuring channels

DigiVision PROFESSIONAL (add-on functions)

- Measurement rate up to 1200 measurements/s
- Supports up to 32 measuring channels
- Freely configurable extra mathematical channels

Highlights of all versions

- Automatic scaling
- Measurement reports can be saved as Excel or PDF file
- Practical start and stop trigger functions
- Archive viewer for displaying sets of curves

DigiVision software applications

- Measurement of torque, speed, angle, mechanical power and efficiency in engine test benches
- Visualizing and documenting screw-fit curves
- Recording and analyzing holding and friction torque curves

Customer Services

AT YOUR SERVICE!

CUSTOMER ADVICE

The accuracy of your torque measurements relies on applying a high level of technical understanding to assess your entire process chain. Whatever support you may need, from measurement-problem analysis through system startup to recalibration, our experienced design and service engineers can help.

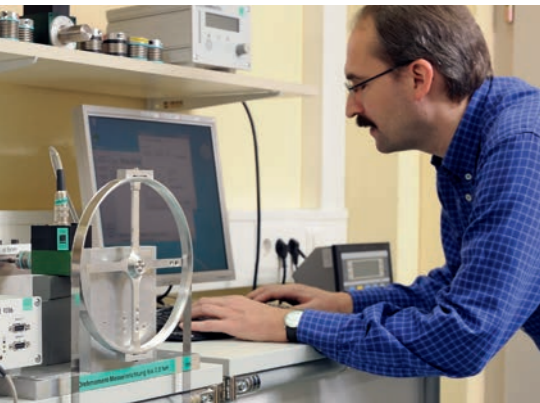

INHOUSE CALIBRATION SERVICES

As a manufacturer, burster also has an ISO 17025 accredited calibration laboratory.

For torque as the measured quantity, we offer not only test and calibration reports and factory calibration certificates but also the option of a German-accredited DAkKS calibration certificate. burster's fast and efficient calibration service ensures reliability, accuracy and traceability for every calibration.

Extract of calibration services		Test & calibration certificate	On-site	Factory calibration certificate	DAkKS calibration certificate
Torque sensor and torque measuring chain	0.02 Nm ... 200 Nm 200 Nm ... 5 kNm	■ ■	■ ■	■ ■*	■ ■*

* external partner

ADJUSTMENT FOR USE WITH EXTERNAL INSTRUMENTS



When connecting an additional display and evaluation unit to the torque sensor, it is essential to adjust the system to ensure correct measurement readings and correct output scaling. We are happy to perform this adjustment of sensor and display for you, and supply a traceable adjustment report with this service. We can also provide adjustment services tailored to your specific needs. We ensure the measurement system is ready for use, leaving you valuable time to spend on other tasks. On request, we can provide you with a traceable adjustment report in conjunction with burster TEDS.

CABLE/CONNECTOR ASSEMBLY

burster torque sensors come with a connecting plug or have a permanently connected cable. For sensors with a plug we offer a range of connecting cables designed for the process environment (e.g. suitable for drag chains, suitable cable length) and fitted with a mating connector for the particular instrument required.

REPAIRS

Our experts in the service repair team will deal with your problem quickly and professionally. Our repairs come with a 24-month guarantee. We also perform an adjustment and firmware update if appropriate for the sensor model and features.



MORE SERVICE COMPONENTS ON OUR WEBSITE www.burster.com

- In the Service login area you can access your calibration certificates and test reports 24/7 wherever you are
- The product cockpit contains all the important information about the product at a glance
- In just a few steps you can integrate the free CAD data for our torque sensors and process instrumentation into your CAD design
- Details for reaching your direct contact
- The download menu provides access to all product-related files such as data sheets, user manuals, brochures, videos and much more

or directly on your QR-Code at your product



OTHER PRODUCTS WE OFFER

Sensors

Miniature and standard tension and compression load cells

- Measurement ranges of 0 ... 1 N to 0 ... 2 MN
- Linearity error from < 0.05 % F.S.
- Various options available such as IP68, nominal temperature range -55 ° to +200 °C, built-in overload protection and much more

Potentiometric, LVDT and incremental displacement sensors

- Measurement ranges of 0 ... 1 mm to 0 ... 2000 mm
- Measurement accuracy starting at ±0.5 µm
- Output signals TTL, 0 ... ±10 VDC, 0/4 ... 20 mA, USB, range of accessories and much more

Pressure transducers (relative and absolute)

- Measurement ranges of 0 ... 35 mbar to 0 ... 5000 bar
- Linearity error from < 0.05 % F.S.
- Easy to fit, rugged, available in a wide choice of designs and options

SENSOR ELECTRONICS

Display and evaluation instruments

Digital panel meters and desktop instruments for sensors

Instrumentation amplifiers

Amplifier modules for strain-gauge and potentiometric sensors, in-line instrumentation amps, fieldbus modules and USB sensor interface

PROCESS MONITORING SYSTEMS

DIGIFORCE® 9307

Universal process controller for torque monitoring, controlling press-fit and joining operations, tracking process curves, signal testing and leak detection

DIGIFORCE® 9311

X/Y monitoring for controlling press-fit, joining and riveting processes

ForceMaster 9110

Low-Cost monitoring for controlling press-fit operations on manual presses

Further information: www.burster.com

THE MEASUREMENT SOLUTION.

burster



BECAUSE PROGRESS NEEDS VISION.

burster, the specialists for measuring equipment and sensors, delivers the ideal solution that meets your requirements to a T. We offer you forward-looking products, system solutions and a comprehensive suite of services to supplement our product range. With personal commitment and an uncompromising focus on quality.

Measuring technology with perspective.

THE MEASUREMENT SOLUTION.

burster

MTS



MTS Messtechnik Schaffhausen GmbH

Mühlenstrasse 4, CH-8260 Stein am Rhein Telefon

+41 52-672 50 00

Telefax +41 52-672 50 01

www.mts.ch, e-mail: info@mts.ch

Messen Prüfen Automatisieren www.mts.ch